

MBR2045CT

SCHOTTKY BARRIER RECTIFIER

MBRF2045CT

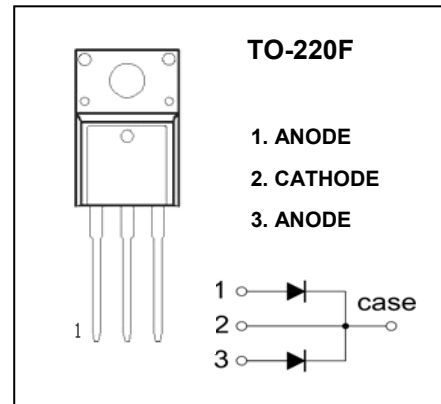
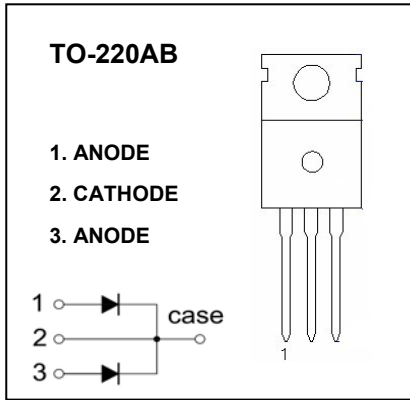

MAXIMUM RATINGS ($T_a=25^{\circ}\text{C}$ unless otherwise noted)

Symbol	Parameter	Value	Unit
V_{RRM}	Peak repetitive reverse voltage	45	V
V_{RWM}	Working peak reverse voltage		
V_R	DC blocking voltage		
$V_{R(RMS)}$	RMS reverse voltage	31.5	V
I_o	Average rectified output current	20	A
I_{FSM}	Non-Repetitive peak forward surge current 5 μ s sine wave	125	A
P_D	Power dissipation	2	W
$R_{\theta JA}$	Thermal resistance from junction to ambient	50	$^{\circ}\text{C}/\text{W}$
T_j	Junction temperature	125	$^{\circ}\text{C}$
T_{stg}	Storage temperature	-55~+150	$^{\circ}\text{C}$

ELECTRICAL CHARACTERISTICS ($T_a=25^{\circ}\text{C}$ unless otherwise specified)

Parameter	Symbol	Test conditions	Min	Typ	Max	Unit
Reverse voltage	$V_{(BR)}$	$I_R=0.1\text{mA}$	45			V
Reverse current	I_R	$V_R=45\text{V}$			0.1	mA
Forward voltage	$V_{F(1)}$	$I_F=5\text{A}$			0.7	V
	$V_{F(2)}^*$	$I_F=10\text{A}$			0.8	